

Grundriss

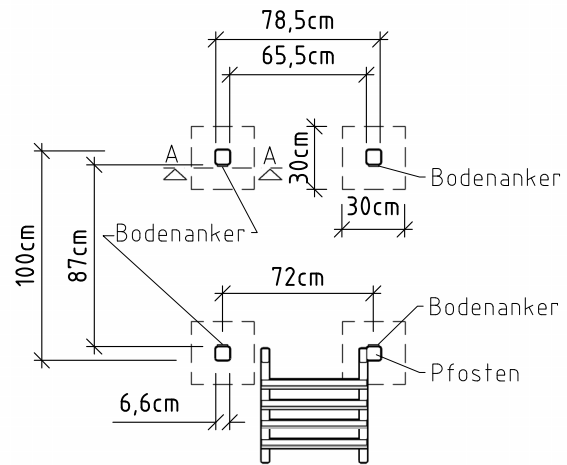

Schnitt A-A

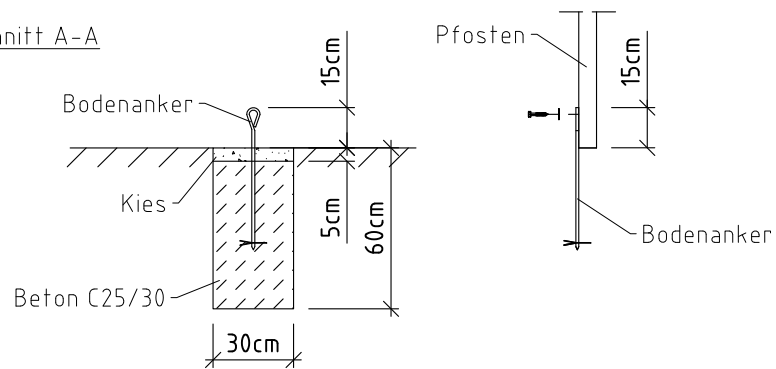

Technische Änderungen vorbehalten!

	Zeichner:	Genehmigt:	Datum:	Darstellung:	Maßstab:	
Erstellt:	Ehlert	Belling	22.05.2019	Fundamentplan	angepasst	
Geändert:				FP816-1001-00-00	Blatt-Nr.:	
Geändert:					1/1	