

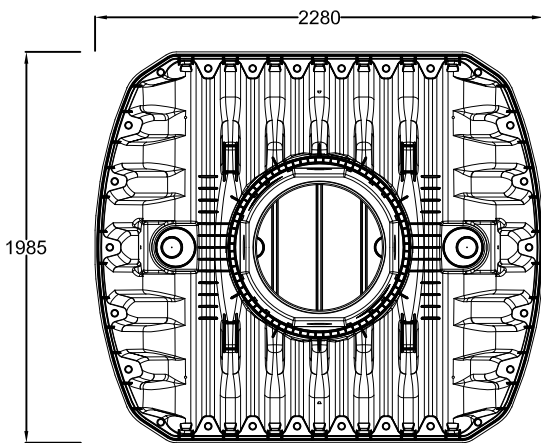

D GRAF Carat Retentionszisterne 4800 L		Artikel-Nr. article no. 370502
GB GRAF Carat retention cistern 4800 L	ES GRAF Sistema de retención Carat tanque 4800 L	FR GRAF Cuve de rétention Carat 4800 L

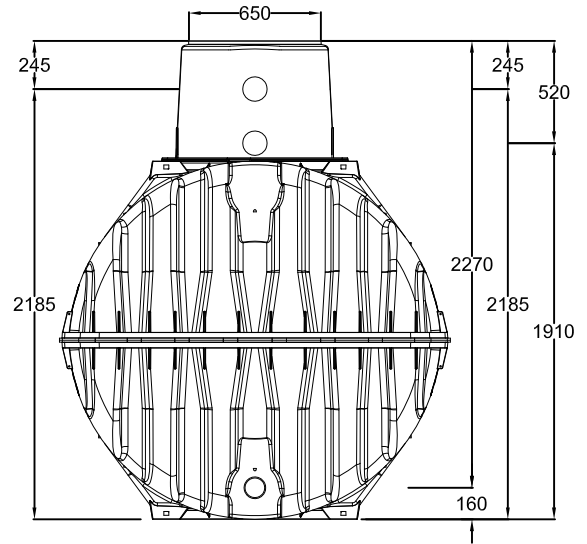
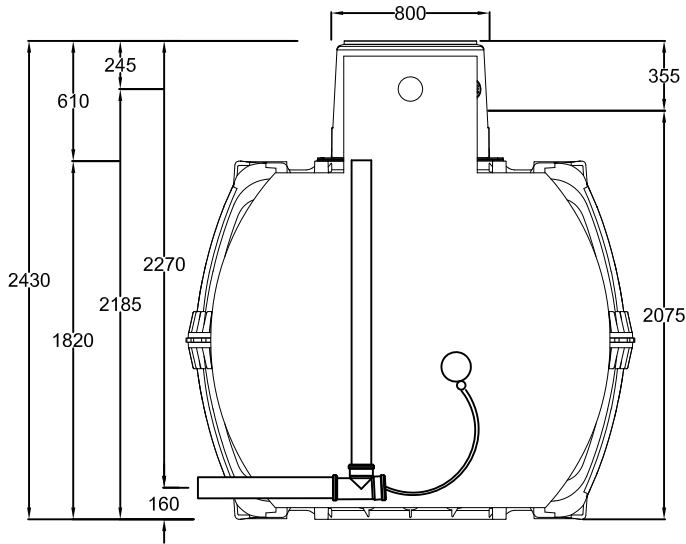

Otto Graf GmbH

Carl-Zeiss-Str. 2-6
DE-79331 Teningen
Germany
info@graf.info
www.graf.info

Zeichnungsinformation drawing information

gezeichnet drawn	NRE
Datum date	29.11.12
Toleranz tolerance	+/- 3 %

Artikelinformation article information

Gewicht weight	170 kg
-------------------	--------

Alle Maßangaben in mm
all dimension in mm