

- Ⓓ **Chrom Auslaufhahn 3/4"**
- Ⓕ **Robinet chromé 3/4"**
- Ⓔ **Brass tap chrome 3/4"**
- Ⓔ **Grifo cromado para anfora o columna 3/4"**
- Ⓘ **Rubinetto di scarico cromato 3/4"**

Montageanleitung
Notice d'installation
Installation Instruction
Instrucciones para montaje
Introduzione d'installazione

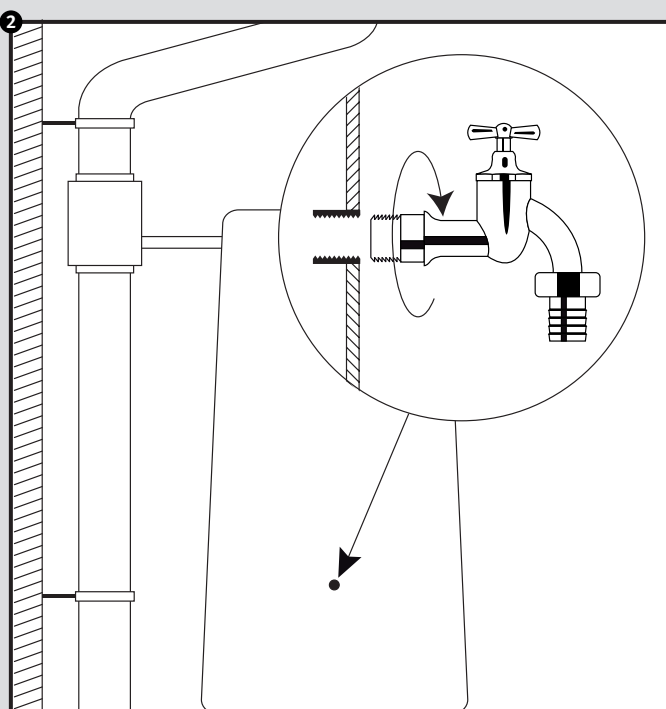
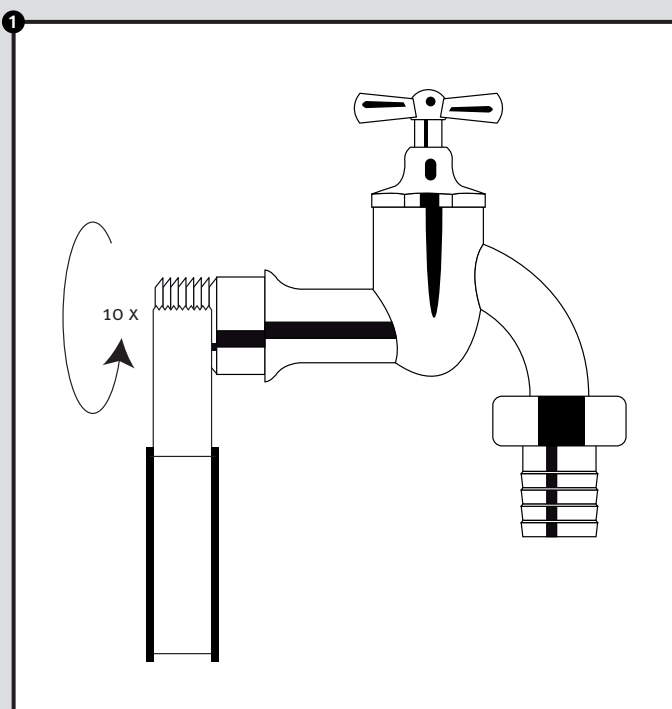
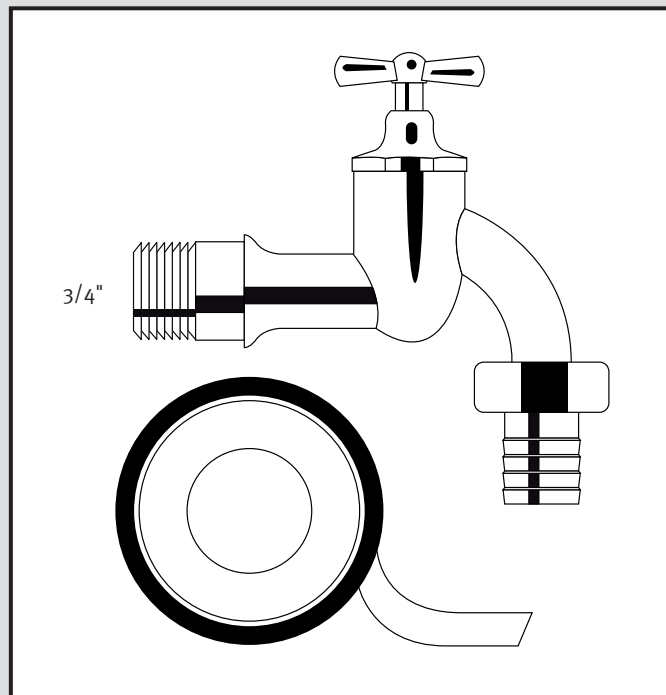
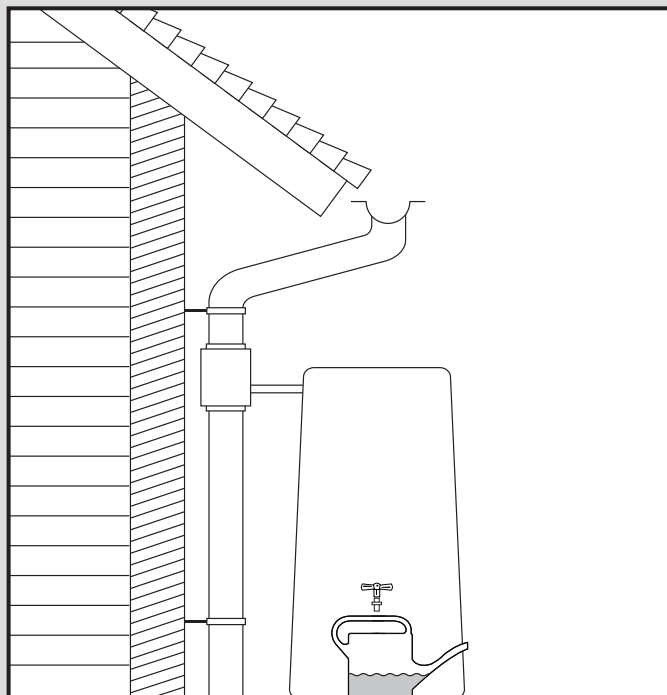

N° 330282

23.05.2014